



# SLG200R12E6H

## 62mm Half Bridge IGBT Module 1200V/200A

### PRODUCT FEATURES 电气特性:

- 1200V 沟槽栅/场终止工艺
- 低开关损耗
- 正温度系数

### 典型应用:

- 逆变焊机
- 感应加热

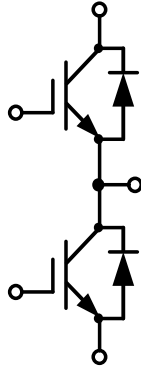

### Equivalent Circuit and Package

E6 Series



$V_{CES} = 1200V$ ,  $I_{C\ nom} = 200A$  /  $I_{CRM} = 400A$

## IGBT, 逆变器 / IGBT, Inverter

### 最大额定值 / Maximum Ratings

Parameter	Conditions	Symbol	Value	Unit
集电极-发射极电压 Collector-Emitter voltage	$T_{vj} = 25^{\circ}C$	$V_{CES}$	1200	V
连续集电极直流电流 Continuous DC collector current	$T_C = 100^{\circ}C$ , $T_{vj\ max} = 175^{\circ}C$	$I_{C\ nom}$	200	A
集电极重复峰值电流 Repetitive peak collector current	$t_p = 1\ ms$	$I_{CRM}$	400	A
总功率损耗 Total power dissipation	$T_C = 25^{\circ}C$ , $T_{vj\ max} = 175^{\circ}C$	$P_{tot}$	1070	W
栅极-发射极电压 Gate emitter voltage		$V_{GE}$	$\pm 20$	V

### 特征值 / Characteristic Values

Parameter	Conditions	Symbol	Value			Unit
			Min.	Typ.	Max.	
集电极-发射极饱和电压 Collector-Emitter saturation voltage	$V_{GE} = 15V$ , $I_C = 200A$ $V_{GE} = 15V$ , $I_C = 200A$ $V_{GE} = 15V$ , $I_C = 200A$	$T_{vj} = 25^{\circ}C$ $T_{vj} = 125^{\circ}C$ $T_{vj} = 150^{\circ}C$	$V_{CESat}$	2.20 2.55 2.75	2.65	V
栅极-发射极阈值电压 Gate-Emitter threshold voltage	$I_C = 7.6mA$ , $V_{GE} = V_{CE}$	$T_{vj} = 25^{\circ}C$	$V_{GE(th)}$	5.20	5.80	6.40
栅电荷 Gate charge	$V_{GE} = -15V \dots +15V$		$Q_G$	1.05		$\mu C$
内部栅极电阻 Internal gate resistor			$R_{Gint}$	2.70		$\Omega$
输入电容 Input capacitance	$f = 1MHz$ , $V_{CE} = 25\ V$ , $V_{GE} = 0\ V$	$T_{vj} = 25^{\circ}C$	$C_{ies}$	14.76		nF

# SLG200R12E6H

## 特征值/Characteristic Values

反向传输电容 Reverse transfer capacitance			$C_{res}$		0.58		nF
集电极-发射极截止电流 Collector-emitter cut-off current	$V_{CE}=1200V, V_{GE}=0V$	$T_{vj}=25^{\circ}C$	$I_{CES}$			2	mA
栅极-发射极漏电流 Gate-emitter leakage current	$V_{CE}=0V, V_{GE}=20V$	$T_{vj}=25^{\circ}C$	$I_{GES}$			200	nA
开通延迟时间 Turn-on delay time	$I_C=200A, V_{CE}=600V$ $V_{GE}=\pm 15V, R_G=2.5\Omega$ (电感负载) / (inductive load)	$T_{vj}=25^{\circ}C$ $T_{vj}=125^{\circ}C$ $T_{vj}=150^{\circ}C$	$t_{d\ on}$		170 175 180		
上升时间 Rise time	$I_C=200A, V_{CE}=600V$ $V_{GE}=\pm 15V, R_G=2.5\Omega$ (电感负载) / (inductive load)	$T_{vj}=25^{\circ}C$ $T_{vj}=125^{\circ}C$ $T_{vj}=150^{\circ}C$	$t_r$		42 44 45		
关断延迟时间 Turn-off delay time	$I_C=200A, V_{CE}=600V$ $V_{GE}=\pm 15V, R_G=2.5\Omega$ (电感负载) / (inductive load)	$T_{vj}=25^{\circ}C$ $T_{vj}=125^{\circ}C$ $T_{vj}=150^{\circ}C$	$t_{d\ off}$		230 290 290		ns
下降时间 Fall time	$I_C=200A, V_{CE}=600V$ $V_{GE}=\pm 15V, R_G=2.5\Omega$ (电感负载) / (inductive load)	$T_{vj}=25^{\circ}C$ $T_{vj}=125^{\circ}C$ $T_{vj}=150^{\circ}C$	$t_f$		120 195 190		
开通损耗能量 (每脉冲) Turn-on energy loss per pulse	$I_C=200A, V_{CE}=600V$ $V_{GE}=\pm 15V, R_G=2.5\Omega$ (电感负载) / (inductive load)	$T_{vj}=25^{\circ}C$ $T_{vj}=125^{\circ}C$ $T_{vj}=150^{\circ}C$	$E_{on}$		9.65 25. 4028.		mJ
关断损耗能量 (每脉冲) Turn-off energy loss per pulse	$I_C=200A, V_{CE}=600V$ $V_{GE}=\pm 15V, R_G=2.5\Omega$ (电感负载) / (inductive load)	$T_{vj}=25^{\circ}C$ $T_{vj}=125^{\circ}C$ $T_{vj}=150^{\circ}C$	$E_{off}$		12.25 16.40 16.85		
短路数据 SC data	$V_{GE}\leq 15V, V_{ce}=800V$ $V_{CEmax}=V_{CES}-L_{sCE}\cdot di/dt \quad t_p\leq 10\mu s, T_{vj}=150^{\circ}C$		$I_{sc}$		680		A
结-外壳热阻 Thermal resistance, junction to case	每个 IGBT / per IGBT		$R_{thJC}$			0.14	K/W
在开关状态下温度 Temperature under switching conditions			$T_{vj\ op}$	-40		150	$^{\circ}C$

## 二极管, 逆变器 / Diode, Inverter

### 最大额定值 / Maximum Ratings

Parameter	Conditions	Symbol	Value	Unit
反向重复峰值电压 Repetitive peak reverse voltage	$T_{vj}=25^{\circ}C$	$V_{RRM}$	1200	V
连续正向直流电流 Continuous DC forward current		$I_F$	200	A
正向重复峰值电流 Repetitive peak forward current	$t_p=1ms$	$I_{FRM}$	400	A
$I^2t$ 值 $I^2t$ -value	$t_p=10ms, \sin 180^{\circ}, T_j=125^{\circ}C$	$I^2t$	7800	$A^2S$

# SLG200R12E6H

## 特征值/Characteristic Values

Parameter	Conditions	Symbol	Value			Unit
			Min.	Typ.	Max.	
正向电压 Forward voltage	$I_F=200A, V_{GE}=0V$ $I_F=200A, V_{GE}=0V$ $I_F=200A, V_{GE}=0V$	$T_{vj}=25^{\circ}C$ $T_{vj}=125^{\circ}C$ $T_{vj}=150^{\circ}C$	$V_F$		2.30 1.90 1.75	2.80 V
反向恢复峰值电流 Peak reverse recovery current	$I_F=200A,$ $-di_F/dt=4498A/\mu s(T_{vj}=150^{\circ}C)$ $V_R=600V, V_{GE}=-15V$	$T_{vj}=25^{\circ}C$ $T_{vj}=125^{\circ}C$ $T_{vj}=150^{\circ}C$	$I_{RM}$		100 130 130	A
恢复电荷 Recovered charge	$I_F=200A,$ $-di_F/dt=4498A/\mu s(T_{vj}=150^{\circ}C)$ $V_R=600V, V_{GE}=-15V$	$T_{vj}=25^{\circ}C$ $T_{vj}=125^{\circ}C$ $T_{vj}=150^{\circ}C$	$Q_r$		6.00 18. 7023	$\mu C$
反向恢复损耗（每脉冲） Reverse recovered energy	$I_F=200A,$ $-di_F/dt=4498A/\mu s(T_{vj}=150^{\circ}C)$ $V_R=600V, V_{GE}=-15V$	$T_{vj}=25^{\circ}C$ $T_{vj}=125^{\circ}C$ $T_{vj}=150^{\circ}C$	$E_{rec}$		<del>5.70</del> 19. 0020.	mJ
结-外壳热阻 Thermal resistance, junction to case	每个二极管 / per diode		$R_{thJC}$		80	0.20 K/W
在开关状态下温度 Temperature under switching conditions			$T_{vj op}$	-40		150 $^{\circ}C$

## 模块 / Module

Parameter	Conditions	Symbol	Value			Unit
绝缘测试电压 Isolation test voltage	RMS, f=50Hz, t=1min	$V_{ISOL}$		4000		V
内部绝缘 Internal isolation				$Al_2O_3$		
储存温度 Storage temperature		$T_{stg}$	-40		125	$^{\circ}C$
模块安装的扭矩 Mounting torque for modul mounting		M	3.0		6.0	Nm
重量 Weight		W		324		g



图 1. 典型输出特性 ( $V_{GE}=15V$ )

Figure 1. Typical output characteristics ( $V_{GE}=15V$ )

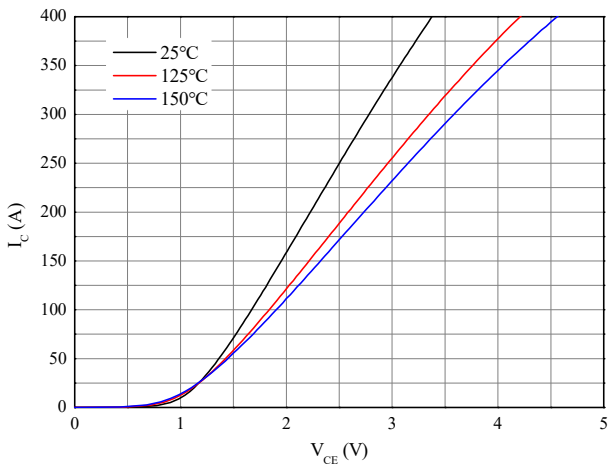

图 2. 典型输出特性 ( $T_{vj}=150^{\circ}C$ )

Figure 2. Typical output characteristics ( $T_{vj}=150^{\circ}C$ )

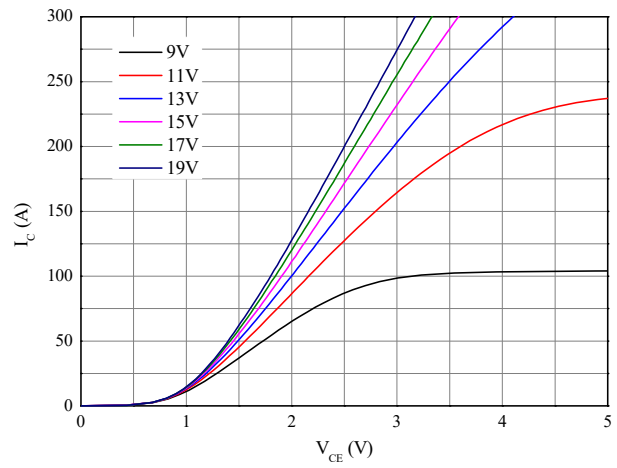

图 3. 典型传输特性 ( $V_{CE}=20V$ )

Figure 3. Typical transfer characteristic ( $V_{CE}=20V$ )

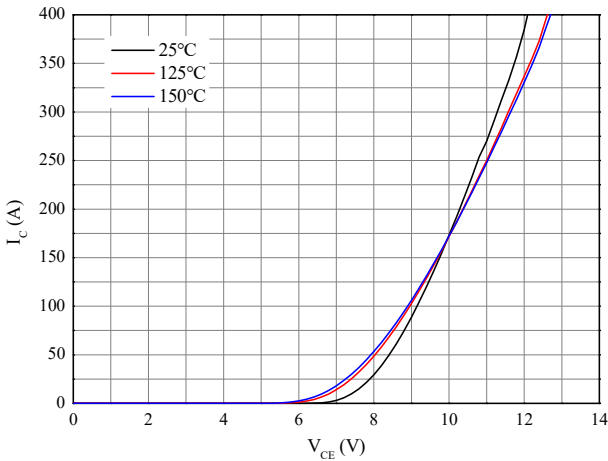

图 4. 正向偏压特性 二极管

Figure 4. Forward characteristic of Diode

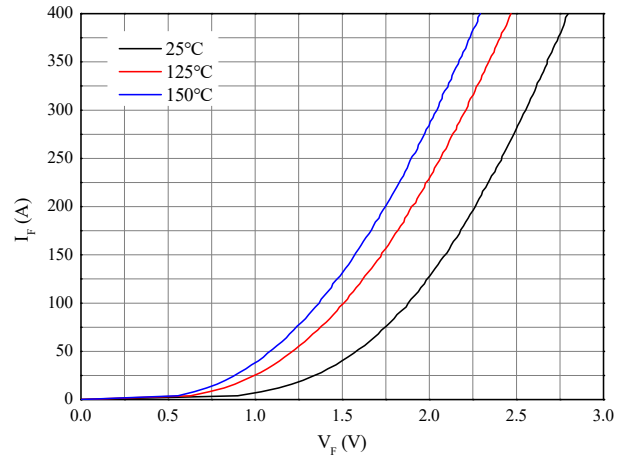

图 5. 开关损耗 逆变器

Figure 5. Switching losses of IGBT  
 $V_{GE}=\pm 15V, R_{Gon}=2.5\Omega, R_{Goff}=2.5\Omega, V_{CE}=600V$

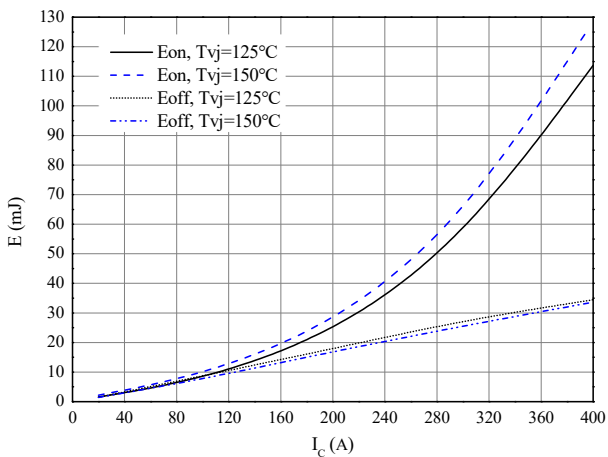

图 6. 开关损耗 逆变器

Figure 6. Switching losses of IGBT  
 $V_{GE}=\pm 15V, I_C=200A, V_{CE}=600V$

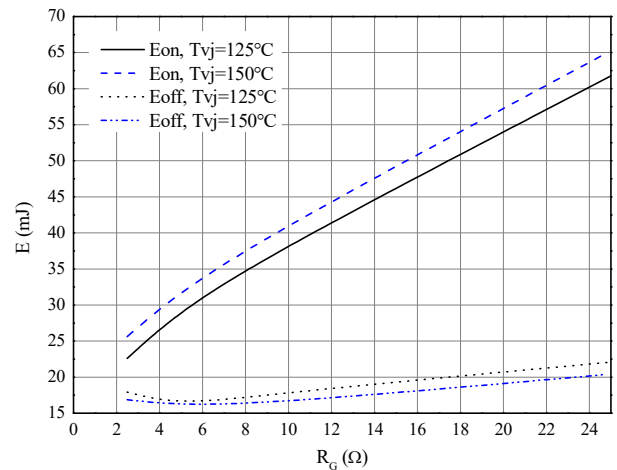

图 7. 开关损耗 二极管

Figure 7. Switching losses of Diode

$R_{Gon}=2.5\ \Omega$ ,  $V_{CE}=600\text{V}$

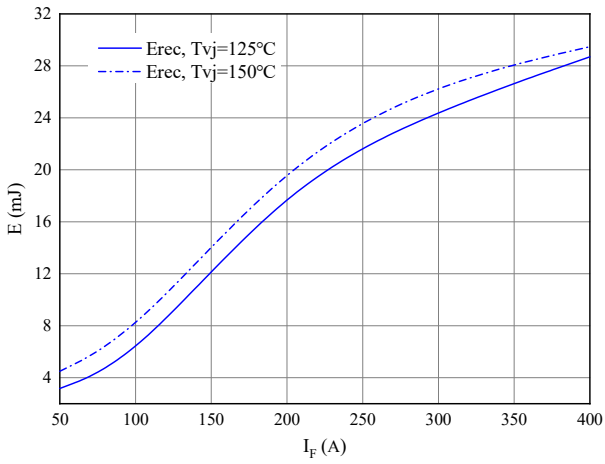

图 8. 开关损耗 二极管

Figure 8. Switching losses of Diode

$I_F=200\text{A}$ ,  $V_{CE}=600\text{V}$

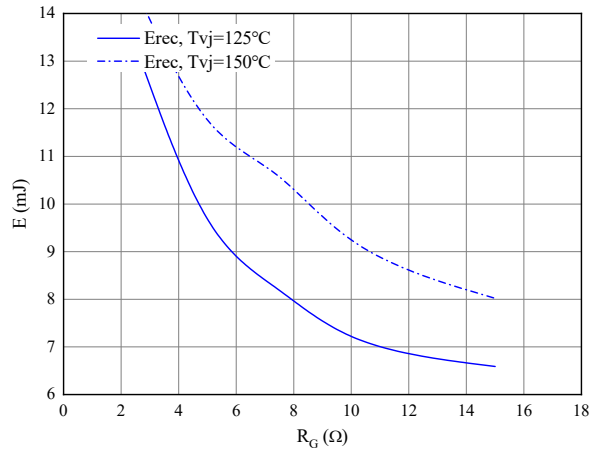

图 9. 电容特性

Figure 9. Capacitance characteristic

# SLG200R12E6H

## 接线图 / Circuit diagram

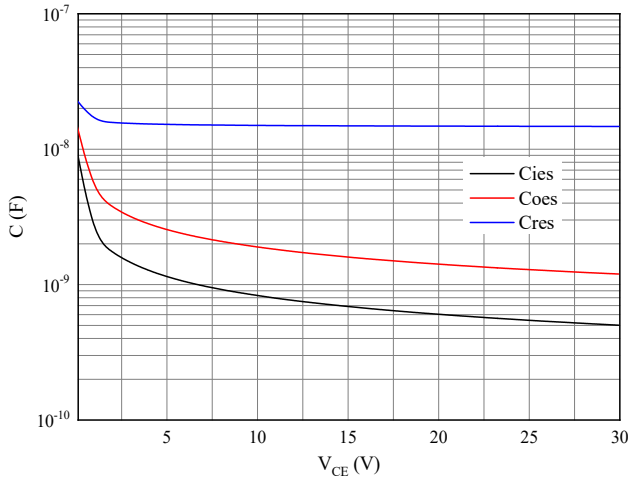
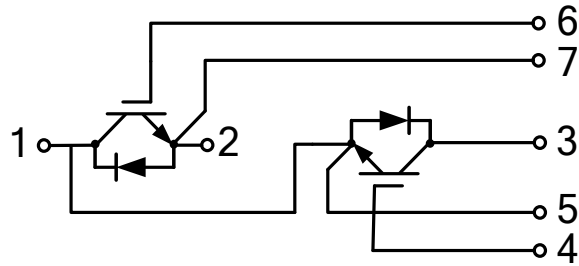

## 封装尺寸 / Package outlines

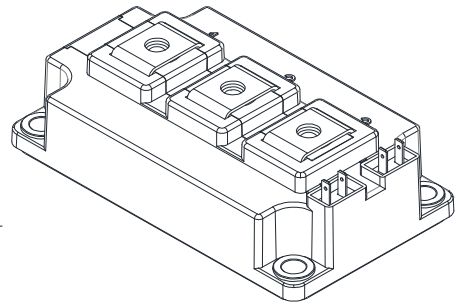
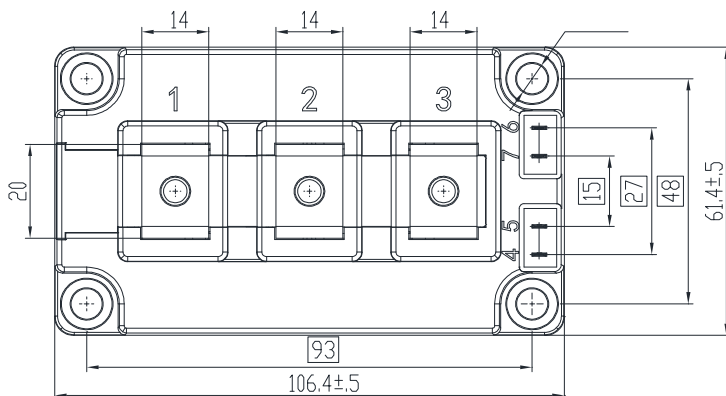
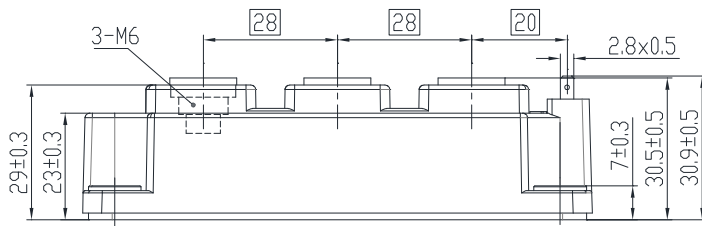

Unit:mm

www.shilingsemi.com